









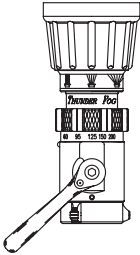

1.5" (38mm) THUNDERFOG® SERIES
 30, 60, 95, 125, 150 & 200 gpm
 (110, 230, 360, 470, 570 & 750 l/min)

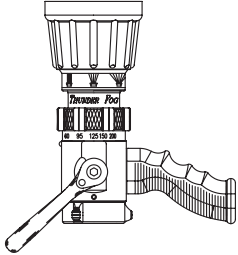
FoamJet Models for
 ThunderFog Series
 FJ-MX-FT

<p>Selectable Gallonage 1.5" Nozzles</p> <p>NFPA 1964 COMPLIANT</p>	  Nozzle Tip Only	  Nozzle w/Shutoff	  Nozzle w/Shutoff & Pistol Grip	
	100 psi NH Threads Fixed Teeth	FT200F	FTS200F	FT200PF
	100 psi NPSH Threads Fixed Teeth	FT200F-IF	FTS200F-IF	FT200PF-IF
	75 psi NH Threads Fixed Teeth	FT200LF	FQS125LF	FT200LPF
	75 psi NPSH Threads Fixed Teeth	FT200LF-IF	FQS125LF-IF	FT200LPF-IF
	100 psi NH Threads Spinning Teeth	FT200S	FTS200S	FTS200PS
	100 psi NPSH Threads Spinning Teeth	FT200S-IF	FTS200S-IF	FTS200PS-IF
	75 psi NH Threads Spinning Teeth	FT200LS	FTS200LS	FTS200LPS
	75 psi NPSH Threads Spinning Teeth	FT200LS-IF	FTS200LS-IF	FTS200LS-IF

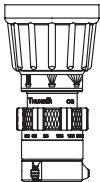
1.5" (38mm) THUNDERFOG® SERIES
 95, 125, 150, 200 & 250 gpm (360, 470, 570, 750 & 950 l/min)

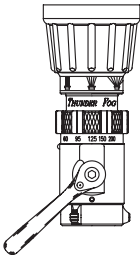
FoamJet Models for
 ThunderFog Series
 FJ-MX-FT

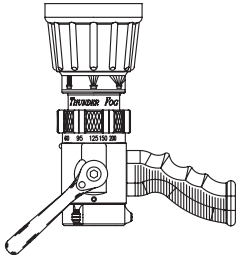
<p>Selectable Gallonage 1.5" Nozzles</p> <p>NFPA 1964 COMPLIANT</p>	  Nozzle Tip Only	  Nozzle w/Shutoff	  Nozzle w/Shutoff & Pistol Grip	
	100 psi NH Threads Fixed Teeth	FT250F	FTS250F	FTS250PF
	100 psi NPSH Threads Fixed Teeth	FT250F-IF	FTS250F-IF	FTS250PF-IF
	100 psi NH Threads Spinning Teeth	FT250S	FTS250S	FTS250PS
	100 psi NPSH Threads Spinning Teeth	FT250S-IF	FTS250S-IF	FTS250PS-IF

2.5" (65mm) THUNDERFOG® SERIES

95 - 250 GPM (360 - 950 l/min)

Selectable Gallonage

The Thunderfog is available with a selectable flow range of 95-250 gpm. The 250 series will work with 2.5" or 3" hose lines. All Thunderfogs are NFPA compliant, and are available in tip only configuration, or with stainless steel shut-off ball, and optional colored pistol grips. All Thunderfogs accept the FJ-MX-FT FOAMJET multi-expansion foam aspirating attachment, and are available with your choice of Fixed (F) or stainless steel Spinning (S) fog teeth. Metric calibrations available: 360-470-570-750-950 l/min @ 7 bar – consult factory for model numbers.

Model# Suffix: F = Fixed Teeth S = Spinning Teeth -IJ = NPSH Threads

JT250F
JT250F-IJ
JT250S
JT250S-IJ
\$645.00
4.7 lb (2.1kg)
9-3/8" (23.8cm)

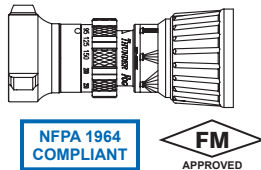

2.5" 95-250 GPM SERIES (360-950 l/min)

JT250 THUNDERFOG TIP 2.5" NH - Selectable gallonage nozzle with five flow settings of 95, 125, 150, 200, and 250 gpm @ 100 psi (360-470-570-750-950 l/min @ 7 bar). All lightweight materials, hardcoat anodized aluminum. Flush without shutting down. Uniquely cut fixed fog teeth or optional stainless steel spinning teeth. This tip only design has an "off" position for break-and-extend operations. 2.5" NH rigid rocker lug coupling is standard.

-IJ = 2.5" NPSH Threads

JTS250F
JTS250F-IJ
JTS250S
JTS250S-IJ
\$950.00
6.0 lb (2.7kg)
11.4" (28.9cm)

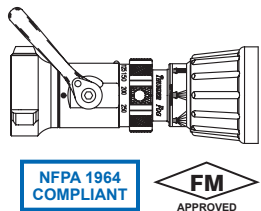

JTS250 THUNDERFOG NOZZLE 2.5" NH - Selectable gallonage nozzle with five flow settings of 95, 125, 150, 200, and 250 gpm @ 100 psi (360-470-570-750-950 l/min @ 7 bar). All lightweight materials, hardcoat anodized aluminum. Flush without shutting down. Uniquely cut fixed fog teeth or optional stainless steel spinning teeth. Quick-change rear valve seat and stainless steel shut-off ball. 2.5" NH swivel rocker lug coupling is standard.

-IJ = 2.5" NPSH Threads

JTS250PF
JTS250PF-IJ
JTS250PS
JTS250PS-IJ
\$1000.00
6.3 lb (2.9kg)
11.4" (28.9cm)

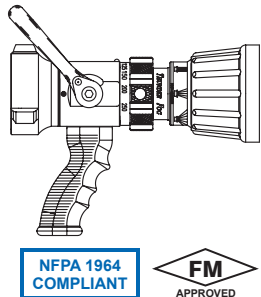

JTS250P THUNDERFOG W/GRIP 2.5" NH - Selectable gallonage nozzle with five flow settings of 95, 125, 150, 200, and 250 gpm @ 100 psi (360-470-570-750-950 l/min @ 7 bar). All lightweight materials, hardcoat anodized aluminum. Flush without shutting down. Uniquely cut fixed fog teeth or optional stainless steel spinning teeth. Quick-change rear valve seat and stainless steel shut-off ball. Pistol grip is mounted below the valve. 2.5" NH swivel rocker lug coupling is standard.

-IJ = 2.5" NPSH Threads

JTS250PPF
JTS250PPF-IJ
JTS250PPS
JTS250PPS-IJ
\$1185.00
9.2 lb (4.2kg)
15.4" (39.1cm)

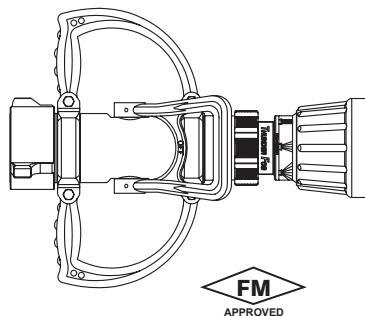





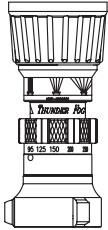

JTS250PP THUNDERFOG PLAYPIPE 2.5" NH - Smallest, most compact nozzle/playpipe combination available for use on 2.5" or 3" lines. Selectable gallonage nozzle with five flow settings of 95, 125, 150, 200, and 250 gpm @ 100 psi (360-470-570-750-950 l/min @ 7 bar). All lightweight materials, hardcoat anodized aluminum. Flush without shutting down. Uniquely cut fixed fog teeth or optional stainless steel spinning teeth. Quick-change rear valve seat and stainless steel shut-off ball. Lightweight hardcoat anodized aluminum alloy for maximum corrosion and wear. Nozzle is attached to valve and is not removable. Rubber coated playpipe handles are designed to reduce fatigue. 2.5" NH full-time swivel rocker lug coupling is standard.

-IJ = 2.5" NPSH Threads

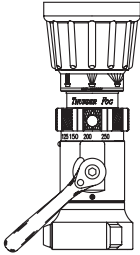
2.5" (65mm) THUNDERFOG® SERIES
 95, 125, 150, 200 & 250GPM
 (360, 470, 570, 750 & 950l/min)

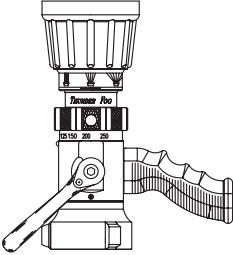
FoamJet Models for
 QuadraFog Series
 FJ-MX-FT

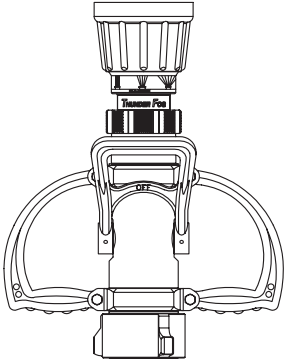
<p>2.5" Selectable Gallonage Nozzles With Fixed or Spinning Teeth</p> <p>NFPA 1964 COMPLIANT</p>	  Nozzle Tip Only	  Nozzle w/Shutoff	  Nozzle w/Shutoff & Pistol Grip	  Nozzle w/Shutoff & Playpipe Grip	
	100 psi NH Threads Fixed Teeth	JT250F	JTS250F	JTS250PF	JTS250PPF
	100 psi NPSH Threads Fixed Teeth	JT250F-IJ	JTS250F-IJ	JTS250PF-IJ	JTS250PPF-IJ
	100 psi NH Threads Spinning Teeth	JT250S	JTS250S	JTS250PS	JTS250PPS
	100 psi NPSH Threads Spinning Teeth	JT250S-IJ	JTS250S-IJ	JTS250PS-IJ	JTS250PPS-IJ