



# MANUAL: Twister® and BubbleCup® Nozzles

## INSTRUCTIONS FOR INSTALLATION, SAFE OPERATION AND MAINTENANCE



Understand manual before use. Operation of this device without understanding the manual and receiving proper training is a misuse of this equipment. Obtain safety information at [www.tft.com/serial-number](http://www.tft.com/serial-number)

This instruction manual is intended to familiarize firefighters and maintenance personnel with the operation, servicing and safety procedures associated with the Twister and BubbleCup Handline fire fighting nozzles.

This manual should be kept available to all operating and maintenance personnel.

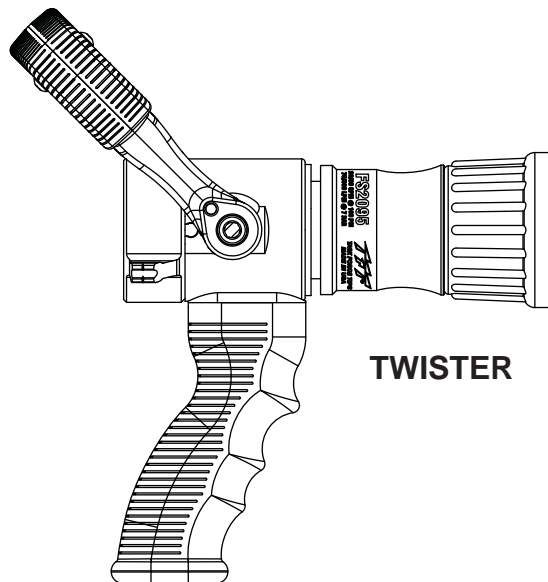

**TWISTER**

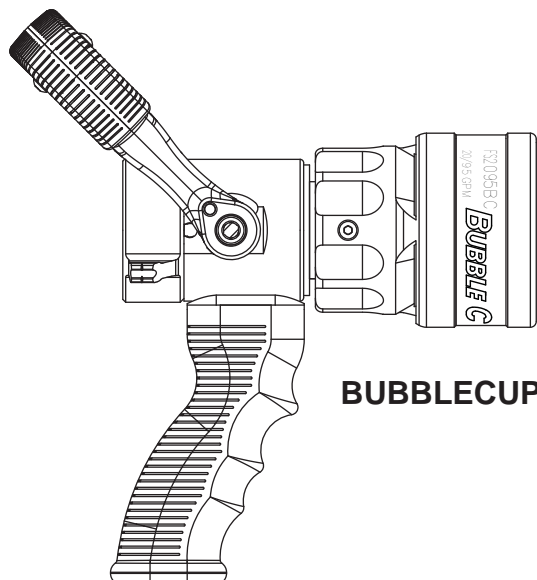

**BUBBLECUP**



### PERSONAL RESPONSIBILITY CODE

The member companies of FEMSA that provide emergency response equipment and services want responders to know and understand the following:

1. Firefighting and Emergency Response are inherently dangerous activities requiring proper training in their hazards and the use of extreme caution at all times.
2. It is your responsibility to read and understand any user's instructions, including purpose and limitations, provided with any piece of equipment you may be called upon to use.
3. It is your responsibility to know that you have been properly trained in Firefighting and/or Emergency Response and in the use, precautions, and care of any equipment you may be called upon to use.
4. It is your responsibility to be in proper physical condition and to maintain the personal skill level required to operate any equipment you may be called upon to use.
5. It is your responsibility to know that your equipment is in operable condition and has been maintained in accordance with the manufacturer's instructions.
6. Failure to follow these guidelines may result in death, burns or other severe injury.



Fire and Emergency Manufacturers and Service Association  
P.O. Box 147, Lynnfield, MA 01940 • [www.FEMSA.org](http://www.FEMSA.org)

**TASK FORCE TIPS, INC.**  
MADE IN USA • [www.tft.com](http://www.tft.com)





3701 Innovation Way, Valparaiso, IN 46383-9327 USA  
800-348-2686 • 219-462-6161 • Fax 219-464-7155

# Table Of Contents





- 1.0 MEANING OF SAFETY SIGNAL WORDS
- 2.0 SAFETY
- 3.0 GENERAL INFORMATION
  - 3.1 VARIOUS MODELS AND TERMS
  - 3.2 SPECIFICATIONS
    - 3.2.1 MECHANICAL
  - 3.3 NOZZLE COUPLINGS
  - 3.4 USE WITH SALT WATER
- 4.0 FLOW CHARACTERISTICS
- 5.0 TWISTER AND BUBBLECUP FLOWS
  - 5.1 STANDARD
  - 5.2 METRIC
- 6.0 NOZZLE CONTROLS
  - 6.1 BALL VALVE SHUTOFF
  - 6.2 TIP ONLY NOZZLES
  - 6.3 PATTERN AND FLUSH CONTROL
    - 6.3.1 PATTERN CONTROL
    - 6.3.2 FLUSH SETTING
  - 6.4 BUBBLECUP NOZZLES
- 7.0 USE WITH FOAM
  - 7.1 FOAM ASPIRATING ATTACHMENTS
- 8.0 USE OF NOZZLES
- 9.0 COLOR CODED VALVE HANDLE AND PISTOL GRIP
- 10.0 DRAWINGS AND PART LISTS
  - 10.1 D SERIES TWISTER AND BUBBLECUP
  - 10.2 F SERIES TWISTER AND BUBBLECUP
- 11.0 WARRANTY
- 12.0 MAINTENANCE
  - 12.1 FIELD LUBRICATION
  - 12.2 SERVICE TESTING
    - 12.2.1 HYDROSTATIC TESTING
    - 12.2.2 FLOW TESTING
    - 12.2.3 RECORDS
  - 12.3 REPAIR
- 13.0 OPERATION and INSPECTION CHECKLIST

## 1.0 MEANING OF SAFETY SIGNAL WORDS

A safety related message is identified by a safety alert symbol and a signal word to indicate the level of risk involved with a particular hazard. Per ANSI standard Z535.6-2011, the definitions of the four signal words are as follows:

-  **DANGER** indicates a hazardous situation which, if not avoided, will result in death or serious injury.
-  **WARNING** indicates a hazardous situation which, if not avoided, could result in death or serious injury.
-  **CAUTION** indicates a potentially hazardous situation which, if not avoided, could result in minor or moderate injury.
-  **NOTICE** is used to address practices not related to physical injury.

## 2.0 SAFETY

-  **DANGER** An inadequate supply of nozzle pressure and/or flow will cause an ineffective stream and can result in injury, death, or loss of property. See flow graphs or call 800-348-2686 for assistance.
-  **WARNING** The nozzle may be damaged if frozen while containing significant amounts of water. Such damage may be difficult to detect visually and can lead to possible injury or death. Any time the nozzle is subject to possible damage due to freezing, it must be tested by qualified personnel before being considered safe for use.
-  **WARNING** This equipment is intended for use by trained personnel for firefighting. Their use for other purposes may involve hazards not addressed by this manual. Seek appropriate guidance and training to reduce risk of injury.
-  **WARNING** Failure to restrain nozzle reaction can cause firefighter injury from loss of footing and/or stream protection. Nozzle reaction will vary as supply conditions change: such as opening or closing other nozzles, hose line kinks, changes in pump settings, etc. Changes in spray pattern or flushing will also affect nozzle reaction. The nozzle operator must always be prepared in the event of these changes.
-  **WARNING** If nozzle gets out of control or away from operator, retreat from nozzle immediately. Do not attempt to regain control of nozzle while flowing water. Injury from whipping can occur.

## ⚠️ WARNING

Water is a conductor of electricity. Application of water on high voltage equipment can cause injury or death by electrocution. The amount of current that may be carried back to the nozzle will depend on the following factors:

- Voltage of the line or equipment
- Distance from the nozzle to the line or equipment
- Size of the stream
- Whether the stream is solid or broken
- Purity of the water. Refer to *The Fire Fighter and Electrical Equipment*, The University of Michigan Extension Service, Fourth Printing 1983. Page 47

## ⚠️ CAUTION

Fire streams are capable of injury and damage. Do not direct water stream to cause injury or damage to persons or property.

### 3.0 GENERAL INFORMATION

The Task Force Tips Twister and Bubblecup nozzles are hand-held nozzles with clean far reaching straight stream. They are adjustable from straight stream to a wide fog pattern. Their rugged construction is compatible with the use of fresh water as well as fire fighting foam solutions. The nozzles are constructed of hard anodized aluminum, stainless steel, rubber and engineering grade polymers. A summary of each nozzle's characteristics is shown in the tables below.

### 3.1 VARIOUS MODELS AND TERMS

SERIES	MODEL	STANDARD COUPLING SIZE	GALLONAGE SETTINGS (GPM AT 100 PSI)
C	TWISTER	3/4 GHT	10, 24
D	TWISTER or BUBBLECUP	1 NH	10, 24
D	TWISTER or BUBBLECUP	1 NH	10, 40
F	TWISTER or BUBBLECUP	1-1/2 NH	20, 60
F	TWISTER	1-1/2 NH	20, 95
F	BUBBLECUP	1-1/2 NH	95 Single Gallonage Only

The C series Twister is available in a tip-only nozzle configuration. The D and F Series Twisters and Bubble Cups are available in tip-only, ball-valve, or ball-valve with pistol grip configurations.

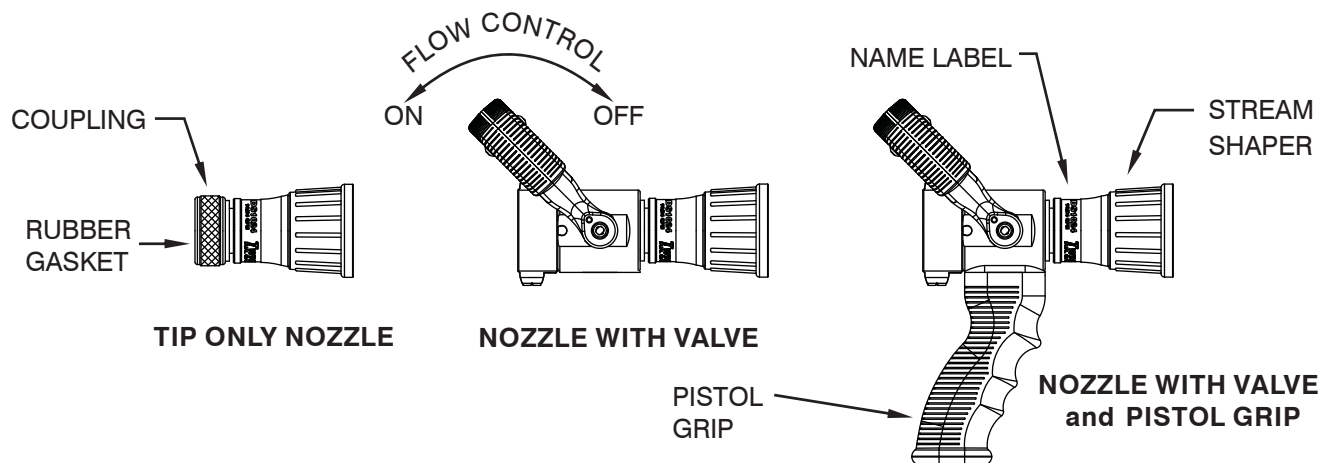

FIGURE 1 COMMON MODELS AND TERMS

### 3.2 SPECIFICATIONS

#### 3.2.1 MECHANICAL

Maximum nozzle inlet pressure with valve shutoff*	Twister 300 psi	20 bar
	BubbleCup 300 psi	20 bar
Operating temperature range of fluid	33 to 120° F	1 to 50° C
Storage temperature range	-40 to 150° F	-40 to 65° C
Materials used	Aluminum 6000 series hard anodized MIL8625 class 3 type 2, stainless steel 300 series, nylon 6-6, nitrile rubber	
*Consult Factory for higher pressure applications		

### 3.3 NOZZLE COUPLINGS

Many inlet couplings such as NH (National Hose) or NPSH (National Pipe Straight Hose) can be specified at time of order.



Nozzle must be mated to a hose line with matched threads. Mismatched or damaged threads may cause nozzle to leak or uncouple under pressure and could cause injury.



Dissimilar metals coupled together can cause galvanic corrosion that can result in the inability to unscrew the threads or complete loss of thread engagement over time. Per NFPA 1962, if dissimilar metals are left coupled together an anti-corrosive lubricant should be applied to the threads. Also the coupling should be disconnected and inspected at least quarterly.

### 3.4 USE WITH SALT WATER

Use with saltwater is permissible provided nozzle is thoroughly cleaned with fresh water after each use. The service life of the nozzle may be shortened due to the effects of corrosion and is not covered under warranty.

### 4.0 FLOW CHARACTERISTICS

At each flow setting the nozzle is set to a predetermined fixed orifice. Relationship of flow and nozzle pressure at each setting is shown in figures 4A and 4B. Contact the factory or visit the website ([www.tft.com](http://www.tft.com)) for range and trajectory data.

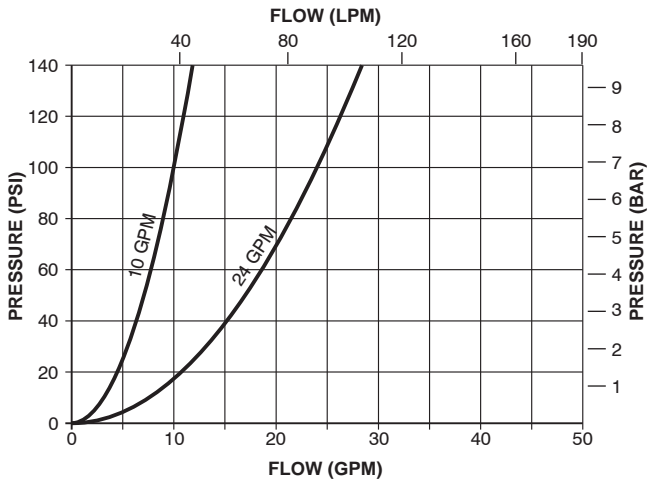

10, 24 GPM TWISTER OR BUBBLE CUP

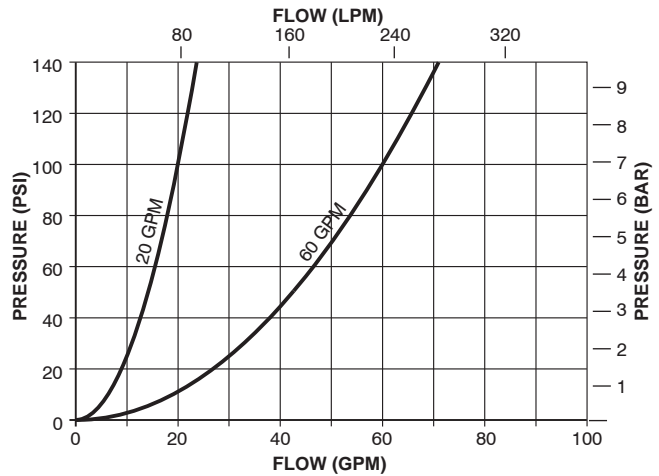

20, 60 GPM TWISTER OR BUBBLE CUP

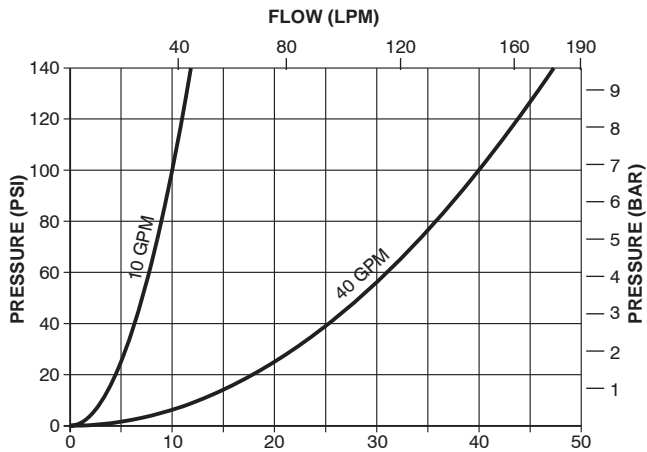

10, 40 GPM TWISTER OR BUBBLE CUP

Figure 4A

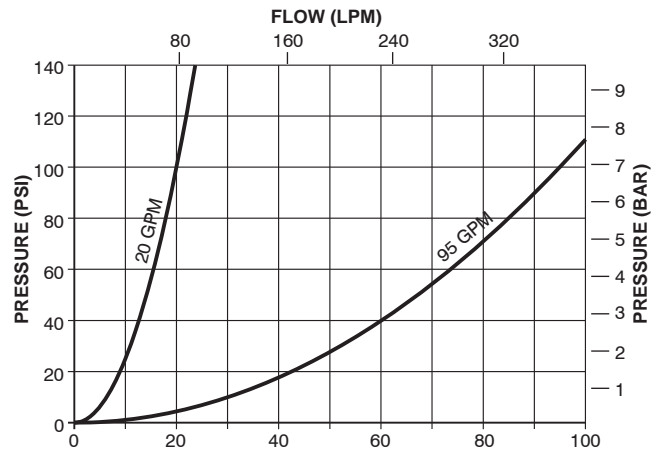

20, 95 GPM TWISTER OR  
95 GPM BUBBLE CUP

Figure 4B

## 5.0 TWISTER AND BUBBLECUP FLOWS

### 5.1 STANDARD

FLOW SETTING	100 FT			200 FT			300 FT			
	10	24	40	10	24	40	10	24	40	
PUMP PRESSURE (PSI)	50	7	13	17	6	11	13	6	10	11
	100	9	19	24	9	16	19	9	14	16
	150	12	23	29	11	20	23	11	17	20
	200	13	27	34	13	23	27	12	20	23
	250	15	30	38	14	25	30	14	22	25
	300	16	33	42	16	28	33	15	24	28
	350	18	35	45	17	30	35	16	26	30
	400	19	38	48	18	32	38	17	28	32
	450	20	40	51	19	34	40	18	30	34
	500	21	42	54	20	36	42	19	32	36
	550	22	44	56	21	37	44	20	33	37
600	23	46	59	22	39	46	21	35	39	

FLOW SETTING	100 FT			200 FT			300 FT			
	10	24	40	10	24	40	10	24	40	
PUMP PRESSURE (PSI)	50	7	16	25	7	16	23	7	15	22
	100	10	23	36	10	22	33	10	21	31
	150	12	28	44	12	27	40	12	26	37
	200	14	33	51	14	31	47	14	30	43
	250	16	36	57	16	35	52	15	34	48
	300	17	40	62	17	38	57	17	37	53
	350	19	43	67	18	41	62	18	40	57
	400	20	46	72	20	44	66	20	43	61
	450	21	49	76	21	47	70	21	45	65
	500	22	51	80	22	50	74	22	48	68
	550	23	54	84	23	52	77	23	50	72
600	24	56	88	24	54	81	24	52	75	

FLOW SETTING	150 FT			200 FT			250 FT			
	20	60	95	20	60	95	20	60	95	
PUMP PRESSURE (PSI)	50	14	40	58	14	39	56	14	38	54
	75	17	49	71	17	48	69	17	47	66
	100	20	56	82	20	55	79	20	54	76
	125	22	63	92	22	62	89	22	61	85
	150	24	69	101	24	68	97	24	67	94
	175	26	75	109	26	73	105	26	72	101
	200	28	80	117	28	78	112	28	77	108
	225	30	85	124	30	83	119	30	82	115
	250	31	89	130	31	88	125	31	86	121

FLOW SETTING	150 FT			200 FT			250 FT			
	20	60	95	20	60	95	20	60	95	
PUMP PRESSURE (PSI)	50	14	41	61	14	40	59	14	40	58
	75	17	50	75	17	49	73	17	49	71
	100	20	58	86	20	57	84	20	56	82
	125	22	64	96	22	64	94	22	63	91
	150	24	71	106	24	70	103	24	69	100
	175	26	76	114	26	75	111	26	74	108
	200	28	82	122	28	80	119	28	79	116
	225	30	86	129	30	85	126	30	84	123
	250	31	91	136	31	90	133	31	89	129

- 1) Number in each box is flow in gallons per minute.
- 2) Actual flows may vary with brand and condition of hose.
- 3) Flows are approximate and do not account for losses in preconnect piping or changes in elevation.

## 5.2 METRIC

### 19mm HOSE

FLOW SETTING	30 Meters			60 Meters			90 Meters		
	10	24	40	10	24	40	10	24	40
PUMP PRESSURE (BAR)									
3.5	25	50	65	25	40	50	25	40	40
7	35	70	90	35	60	70	35	55	60
10	45	85	110	40	75	85	40	65	75
14	50	100	130	50	85	100	45	75	85
17	55	115	145	55	95	115	55	85	95
21	60	125	160	60	105	125	55	90	105
24	70	130	170	65	115	130	60	100	115
28	70	145	180	70	120	145	65	105	120
31	75	150	195	70	130	150	70	115	130
34	80	160	205	75	135	160	70	120	135
38	85	165	210	80	140	165	75	125	140
41	85	175	225	85	150	175	80	130	150

### 25mm HOSE

FLOW SETTING	30 Meters			60 Meters			90 Meters		
	10	24	40	10	24	40	10	24	40
PUMP PRESSURE (PSI)									
3.5	25	60	95	25	60	85	25	55	85
7	40	85	135	40	85	125	40	80	115
10	45	105	165	45	100	150	45	100	140
14	55	125	195	55	115	180	55	115	165
17	60	135	215	60	130	195	55	130	180
21	65	150	235	65	145	215	65	140	200
24	70	165	255	70	155	235	70	150	215
28	75	175	275	75	165	250	75	165	230
31	80	185	290	80	180	265	80	170	245
34	85	195	305	85	190	280	85	180	255
38	85	205	320	85	195	290	85	190	275
41	90	210	335	90	205	305	90	195	285

### 38mm HOSE

FLOW SETTING	45 Meters			60 Meters			75 Meters		
	20	60	95	20	60	95	20	60	95
PUMP PRESSURE (BAR)									
3.5	55	150	220	55	150	210	55	145	205
5.2	65	185	270	65	180	260	65	180	250
7	75	210	310	75	210	300	75	205	290
8.6	85	240	350	85	235	335	85	230	320
10	90	260	380	90	255	365	90	255	355
12	100	285	415	100	275	395	100	275	380
14	105	305	445	105	295	425	105	290	410
15.5	115	320	470	115	315	450	115	310	435
17	115	335	490	115	335	475	115	325	460

### 45mm HOSE

FLOW SETTING	45 Meters			60 Meters			75 Meters		
	20	60	95	20	60	95	20	60	95
PUMP PRESSURE (BAR)									
3.5	55	155	230	55	150	225	55	150	220
5.2	65	190	285	65	185	275	65	185	270
7	75	220	325	75	215	320	75	210	310
8.6	85	240	365	85	240	355	85	240	345
10	90	270	400	90	265	390	90	260	380
12	100	290	430	100	285	420	100	280	410
14	105	310	460	105	305	450	105	300	440
15.5	115	325	490	115	320	475	115	320	465
17	115	345	515	115	340	505	115	335	490

- 1) Number in each box is flow in liters per minute.
- 2) Actual flows may vary with brand and condition of hose.
- 3) Flows are approximate and do not account for losses in preconnect piping or changes in elevation.
- 4) 1BAR = 100 KPA

## 6.0 NOZZLE CONTROLS

Nozzle control valves must be opened slowly to eliminate unnecessary strain on the hose and couplings and reduce pressure surges.

### 6.1 BALL SHUTOFF

Models with a ball valve are shut off when the valve handle is fully forward. Pulling back on the handle opens the valve. Open valve slowly to avoid sudden changes in nozzle reaction. Close valve slowly to prevent water hammer.

The ball valve allows the nozzle operator to regulate the flow of the nozzle depending on the need or what can be safely and effectively handled. TFT recommends the use of a pistol grip for easier handling. For additional stress reduction, a hose rope or strap may also be used. This permits more effective use and ease of advancement, while minimizing strain and fatigue. Note: In partially open positions a ball valve will cause turbulence and adversely affect stream quality. Nozzles attached to an in-service hose shall be stored in the off position.

### 6.2 TIP ONLY NOZZLES

Twister and BubbleCup Tip only nozzles have a twist shut off valve contained within the nozzle.

### 6.3 PATTERN AND FLUSH CONTROL

#### 6.3.1 PATTERN CONTROL

The Twister and BubbleCup nozzles have full pattern control from straight stream to wide fog. Turning the SHAPER clockwise (as seen from the operating position behind the nozzle) moves the SHAPER to the straight stream position. Turning the SHAPER counterclockwise will result in an increasingly wider pattern as well as the nozzle's higher flow setting.

Since the stream trim point varies with the flow, the stream should be 'trimmed' after changing the flow to obtain the straightest and furthest reaching stream. The nozzle reaction is greatest when the shaper is in the straight-stream position.

To properly trim a stream, first open the pattern to a narrow fog. Then close the stream to parallel to give maximum reach. NOTE: Turning the shaper further forward will cause stream crossover and reduce the effective reach of the nozzle.

The nozzle operator must be prepared for a change in reaction as the pattern is changed.

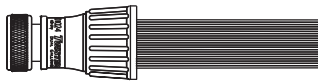

Low & High / Straight Stream

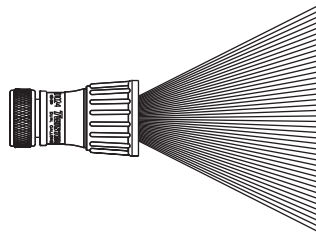

Low & High / Medium Fog

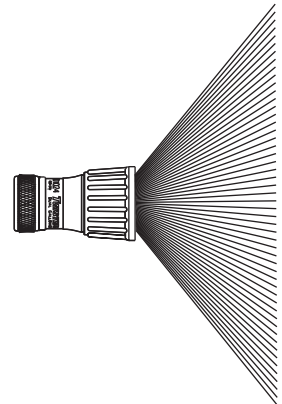

High /Wide Fog

#### 6.3.2 FLUSH SETTING



Large amounts or pieces of debris may be unflushable and can reduce the flow of the nozzle resulting in an ineffective flow. In the event of a blockage, it may be necessary to retreat to a safe area, uncouple the nozzle and remove debris.

## 6.4 BUBBLECUP NOZZLES

The BubbleCup nozzle is capable of producing aspirated foam as well as a conventional straight stream and wide protective fog pattern. The BubbleCup functions just like the BubbleFog nozzle when the aspirating sleeve is in the retracted position as in figure A below.

To use the aspirating feature of the BubbleCup, the nozzle operator needs only slide the aspirating sleeve portion of the nozzle forward as in figure B below. Rotation of the shaper when the sleeve is extended will provide the nozzle operator control of reach and aspiration. If an immediate wide protective fog pattern is needed, the sleeve can be retracted instantly to its regular position

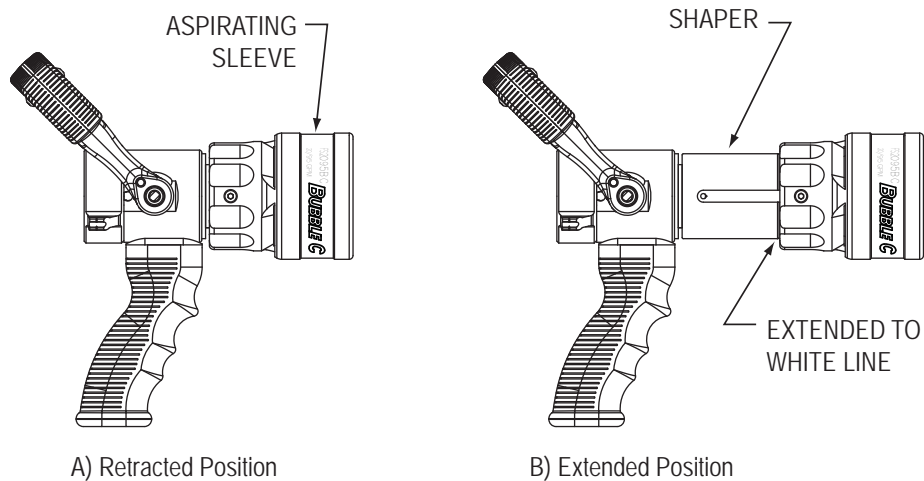

## 7.0 USE WITH FOAM

The nozzle may be used with foam solutions. Refer to fire service training for the proper use of foam.

**WARNING** For Class B fires, lack of foam or interruption in the foam stream can cause a break in the foam blanket and greatly increase the risk of injury or death.

Assure that:

- Application rate is sufficient (see NFPA 11 or foam manufacturer's recommendations)
- Enough concentrate is on hand to complete task (see NFPA for minimum duration time requirements)
- Foam logistics have been carefully planned.

Allow for such things as:

- Storage of foam in a location not exposed to the hazard it protects
- Personnel, equipment and technique to deliver foam at a rapid enough rate
- Removal of empty foam containers
- Clear path to deliver foam, as hoses and other equipment and vehicles are deployed

**WARNING** Improper use of foam can result in injury or damage to the environment. Follow foam manufacturer's instructions and fire service training to avoid:

- Using wrong type of foam on a fire, i.e. Class A foam on a Class B fire
- Plunging foam into pools of burning liquid fuels
- Causing environmental damage
- Directing stream at personnel

**WARNING** There are a wide variety of foam concentrates. Each user is responsible for verifying that any foam concentrate chosen to be used with this unit has been tested to assure that the foam obtained is suitable for the purpose intended.

**WARNING** Use of compressed air foam (CAF) with hand held nozzles can cause sudden surges in nozzle reaction force resulting in risk of injury or death from loss of footing or hose whipping. Be prepared for sudden changes in nozzle reaction caused by:

- Slug loading (Loss of foam concentrate sends slugs of air and water into the nozzle)
- Sudden release of built-up pressure in the hose when opening a nozzle

## 7.1 FOAM ASPIRATING ATTACHMENTS

Multi-expansion or low expansion aspirating attachments may be used with nozzles to increase the expansion ratio. These foam tubes attach and detach quickly from the nozzle. As expansion ratio is increased, the reach of the nozzle will be decreased due to the greater amount of bubbles in the stream and their ability to penetrate the air. Generally the straight stream reach with foam is approximately 10% less than with water only. Actual results will vary based on brand of foam, hardness of water, temperature, etc. For specific information, see LIA-025 (MANUAL: Foam Attachments for TFT Nozzles).



## 8.0 USE OF NOZZLES

Many factors contribute to the extinguishment of a fire. Among the most important is delivering water at a flow rate sufficient to absorb heat faster than it is being generated. The flow rate depends largely on the pump discharge pressure and hose friction loss. It can be calculated using a hydraulic equation such as:

$$PDP = NP + FL + DL + EL$$

**PDP** = Pump discharge pressure in PSI

**NP** = Nozzle pressure in PSI

**FL** = Hose friction loss in PSI

**DL** = Device loss in PSI

**EL** = Elevation loss in PSI

This manual is not intended to act as a training guide for safe fireground tactics and operations. For additional information visit [www.tft.com](http://www.tft.com) or contact customer service at 800-348-2686.

## 9.0 COLOR CODED VALVE HANDLE AND PISTOL GRIP

The TFT nozzle with lever type valve handles are supplied with black valve handle covers and pistol grips. The handle covers and pistol grips are available from TFT in various colors for those departments wishing to color code the nozzle to the discharge controls. A colored handle cover set will be sent upon receipt of the warranty card by TFT. Your department's name can also be engraved on the covers (see warranty card for more information).

Handle covers are replaceable by removing the four screws that hold the handle covers in place. Use a 3/32" Allen wrench when replacing screws. Pistol grip is replaceable by following TFT instruction sheet LTT-108.

For standardization NFPA 1901 (A-4-9.3) recommends the following color code scheme:

Preconnect #1 or Bumper Jump Line	Orange	Other Colors Available:
Preconnect or discharge #2	Red	• Gray
Preconnect or discharge #3	Yellow	• Pink
Preconnect or discharge #4	White	• Purple
Preconnect or discharge #5	Blue	• Tan
Preconnect or discharge #6	Black	
Preconnect or discharge #7	Green	
Foam Lines	Red w/ White border (Red/White)	

# 10.0 DRAWINGS AND PART LISTS

## 10.1 D SERIES TWISTER AND BUBBLECUP

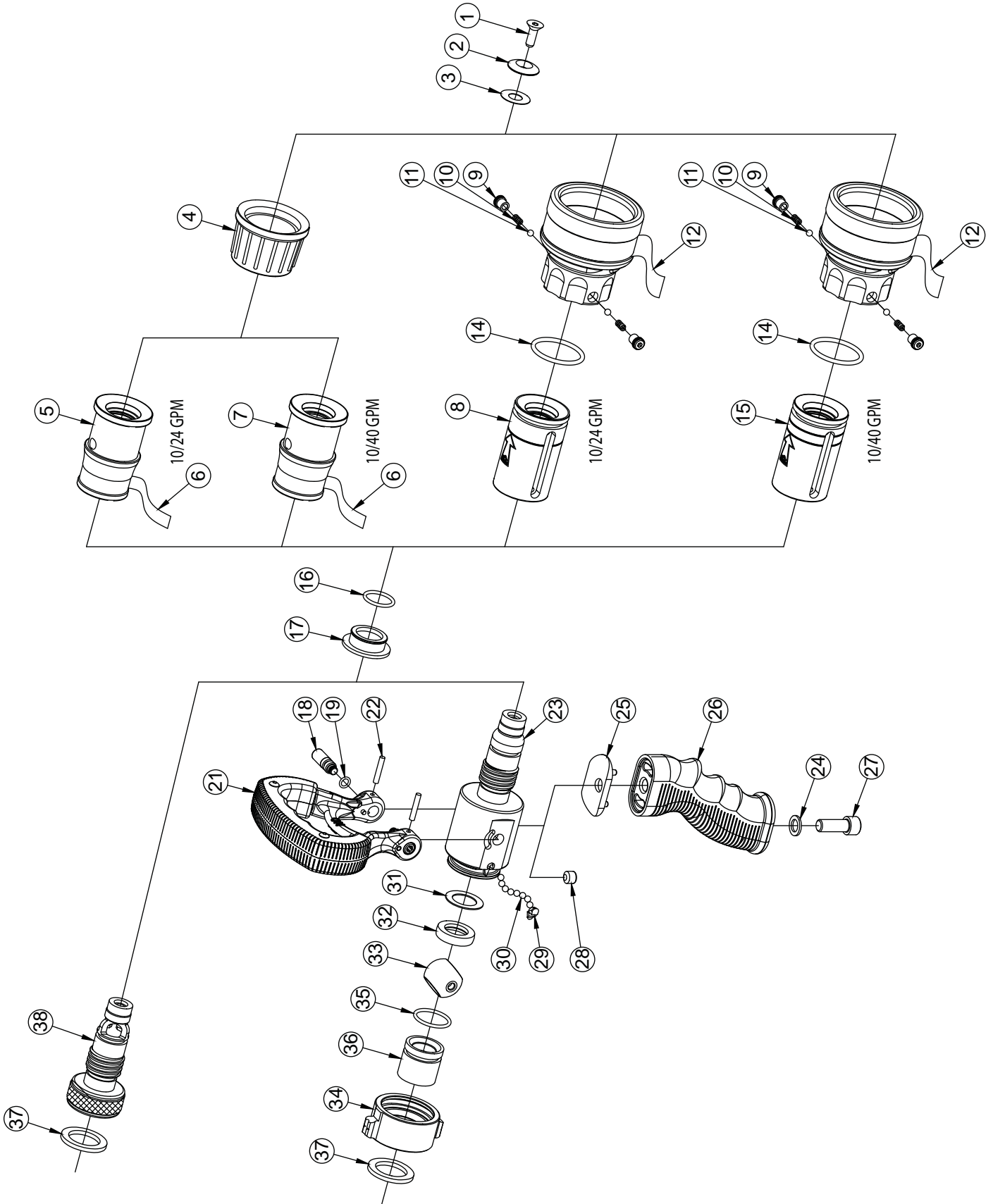

ITEM	DESCRIPTION	QTY	PART #
1	1/4-20 X 3/4 FLAT HEAD SCREW	1	VT25E20FH750
2	BAFFLE	1	D230
3	SEAT	1	D250
4	D TWISTER BUMPER	1	D275
5	HEAD 10/24	1	D225
6*	NAME LABEL	1	DL75
			DL70
7	HEAD 10/40	1	D425
8	FOAM HEAD 10/24	1	D223
9	DETENT SCREW	2	D290
10	SPRING HELICAL COMPRESSION	2	VM4195
11	3/16" TORLON BALL	2	V2120-TORLON
12*	NAME LABEL	1	DL74
			DL73
13	CUP W/TEETH	1	D285
14	O-RING-221	1	VO-221
15	FOAM HEAD 10/40	1	D423
16	O-RING-117	1	VO-117
17	Z STRIP	1	D405
18	75 TRUNNION	2	D07540
19	O-RING-010	2	VO-010
21	DQ HANDLE SUBASSEMBLY	1	DQ860
	75 SHUTOFF HANDLE	1	D07560
	BLACK HANDLE COVER	2	HM625-BLK
	8-32 X 3/8 BUTTON HEAD SCREW	4	VT08-32BH375
	75 STOP PIN	2	D07550
22	SPIROL PIN	2	V1900
23	75 TWISTER VALVE BODY	1	D07525
24	WASHER	1	VM4901
25	GRIP SPACER D075	1	HM693-D
26	PISTOL GRIP - BLACK	1	HM692-BLK
27	3/8-16 X 1 SOCKET HEAD SCREW	1	VT37-16SH1.0
28	3/8-16 X 5/16 SET SCREW	1	VT37-16SS312
29	PORT PLUG	1	B770
30	3/16" SS BALL	26	V2120
31	BELLEVILLE WASHER	1	D07590
32	75 FRONT SEAT	1	D07570
33	75 BALL	1	D07530
34	COUPLING 1.0"F	1	D07597**
35	O-RING-120	1	VO-120
36	75 REAR SEAT	1	D07580
37	GASKET 1.0"	1	V3040
38	BASE 1.0"F	1	D210**

\* - CONSULT FACTORY FOR SPECIFIC PART NUMBERS  
CORRESPONDING TO THE FLOW SETTINGS ON NOZZLE

\*\* - STATE DESIRED THREAD WHEN ORDERING

## 10.2 F SERIES TWISTER AND BUBBLECUP

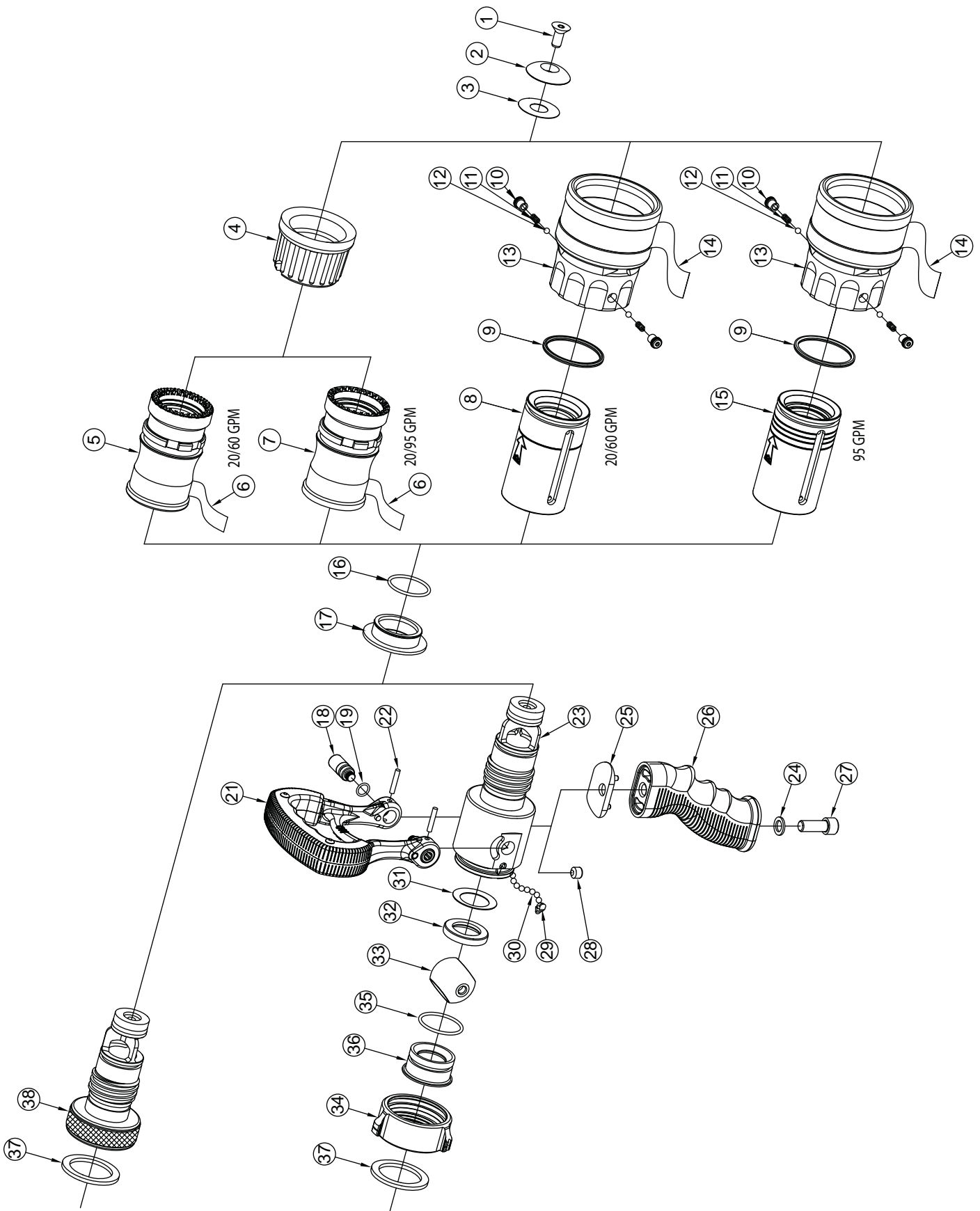

ITEM	DESCRIPTION	QTY	PART #
1	5/16-18 X 3/4 FLAT HEAD	1	VT31E18FH750
2	BAFFLE	1	F630
3	SEAT	1	F650
4	DQ BUMPER	1	DQ275
5	HEAD 20/60	1	F625
6*	LABEL	1	FL70
			FL75
7	HEAD 20/95	1	F925
8	FOAM HEAD 20/60	1	F623
9	QUAD RING-225	1	VOQ-4225
10	DETENT SCREW	2	D290
11	SPRING HELICAL COMPRESSION	2	VM4195
12	3/16" TORLON BALL	2	V2120-TORLON
13	CUP W/TEETH	1	F685
14*	NAME LABEL	1	FL80
			FL82
15	FOAM HEAD 95	1	F923
16	O-RING-125	1	VO-125
17	Z-STRIP	1	F605
18	100 TRUNNION	2	F10040
19	O-RING-012	2	VO-012
21	FQ HANDLE SUBASSEMBLY	1	FQ860
	SHUT OFF HANDLE	1	F10060
	BLACK HANDLE COVER	2	HM625-BLK
	8-32 X 3/8 BUTTON HEAD SCREW	4	VT08-32BH375
	100 STOP PIN	2	F10050
22	SPIROL PIN	2	V1900
23	100 TWISTER VALVE BODY	1	F10025
24	FLAT WASHER	1	VM4901
25	GRIP SPACER F100	1	HM693-F
26	PISTOL GRIP - BLACK	1	HM692-BLK
27	3/8-16 X 1 SOCKET HEAD SCREW	1	VT37-16SH1.0
28	3/8-16 X 5/16 SET SCREW	1	VT37-16SS312
29	PORT PLUG	1	B770
30	3/16" SS BALL	34	V2120
31	BELLEVILLE WASHER	1	F10090
32	100 FRONT SEAT	1	F10070
33	100 BALL	1	F10030
34	COUPLING 1.5"F	1	F10097**
35	O-RING-126	1	VO-126
36	100 REAR SEAT	1	F10080
37	GASKET 1.5"	1	V3130
38	BASE 1.5"F	1	F610**

\* - CONSULT FACTORY FOR SPECIFIC PART NUMBERS  
CORRESPONDING TO THE FLOW SETTINGS ON NOZZLE

\*\* - STATE DESIRED THREAD WHEN ORDERING

## 11.0 WARRANTY

Task Force Tips, Inc., 3701 Innovation Way, Valparaiso, Indiana 46383-9327 USA ("TFT") warrants to the original purchaser of its Twister and BubbleCup series nozzles ("equipment"), and to anyone to whom it is transferred, that the equipment shall be free from defects in material and workmanship during the five (5) year period from the date of purchase.

TFT's obligation under this warranty is specifically limited to replacing or repairing the equipment (or its parts) which are shown by TFT's examination to be in a defective condition attributable to TFT. To qualify for this limited warranty, the claimant must return the equipment to TFT, at 3701 Innovation Way, Valparaiso, Indiana 46383-9327 USA, within a reasonable time after discovery of the defect. TFT will examine the equipment. If TFT determines that there is a defect attributable to it, TFT will correct the problem within a reasonable time. If the equipment is covered by this limited warranty, TFT will assume the expenses of repair.

If any defect attributable to TFT under this limited warranty cannot be reasonably cured by repair or replacement, TFT may elect to refund the purchase price of the equipment, less reasonable depreciation, in complete discharge of its obligations under this limited warranty. If TFT makes this election, claimant shall return the equipment to TFT free and clear of any liens and encumbrances.

This is a limited warranty. The original purchaser of the equipment, any person to whom it is transferred, and any person who is an intended or unintended beneficiary of the equipment, shall not be entitled to recover from TFT any consequential or incidental damages for injury to person and/or property resulting from any defective equipment manufactured or assembled by TFT. It is agreed and understood that the price stated for the equipment is in part consideration for limiting TFT's liability. Some states do not allow the exclusion or limitation of incidental or consequential damages, so the above may not apply to you.

TFT shall have no obligation under this limited warranty if the equipment is, or has been, misused or neglected (including failure to provide reasonable maintenance) or if there have been accidents to the equipment or if it has been repaired or altered by someone else.

THIS IS A LIMITED EXPRESS WARRANTY ONLY. TFT EXPRESSLY DISCLAIMS WITH RESPECT TO THE EQUIPMENT ALL IMPLIED WARRANTIES OF MERCHANTABILITY AND ALL IMPLIED WARRANTIES OF FITNESS FOR A PARTICULAR PURPOSE. THERE IS NO WARRANTY OF ANY NATURE MADE BY TFT BEYOND THAT STATED IN THIS DOCUMENT.

This limited warranty gives you specific legal rights, and you may also have other rights which vary from state to state.

## 12.0 MAINTENANCE

TFT nozzles are designed and manufactured to be damage resistant and require minimal maintenance. However, as the primary firefighting tool upon which your life depends, it should be treated accordingly. Do not drop or throw equipment.

### 12.1 FIELD LUBRICATION

All Task Force Tip nozzles are factory lubricated with high quality silicone grease. This lubricant has excellent washout resistance and long term performance. If your department has unusually hard or sandy water, the moving parts may be affected. Foam agents and water additives contain soaps and chemicals that may break down the factory lubrication.

The moving parts of the nozzle should be checked on a regular basis for smooth and free operation, and signs of damage. IF THE NOZZLE IS OPERATING CORRECTLY, THEN NO ADDITIONAL LUBRICATION IS NEEDED. Any nozzle that is not operating correctly should be immediately removed from service.

### 12.2 SERVICE TESTING

In accordance with NFPA 1962 (2013), nozzles must be tested a minimum of annually. Nozzles failing any part of this test must be removed from service, repaired and retested upon completion of the repair.

#### 12.2.1 HYDROSTATIC TESTING

Each nozzle with a shut off mechanism shall be tested in the following manner.

1. The nozzle shall be placed in a device capable of holding it and the shut off shall be closed.
2. A device capable of exerting a hydrostatic pressure of 300 psi (2070 kPa) or 1.5 times the maximum operating pressure, whichever is higher, shall be attached to the nozzle.
3. All air shall be bled from the system.
4. The gage pressure shall be increased by 50 psi (3.5 bar or 345 kPa) increments, held for 30 seconds at each pressure up to the maximum pressure for which the nozzle is being tested, and then held for one minute without leakage.
5. There shall be no sign of leakage through the valve or shut off.

## 12.2.2 FLOW TESTING

Flow testing must be conducted in the following manner.

1. The nozzle shall be mounted so that the flow rate and pressure through the nozzle and the pressure at the inlet can be accurately measured.
2. With the shut off fully open, the inlet pressure shall be adjusted to the rated pressure  $\pm 2$  percent.
3. The valve or shut off and pattern controls shall be operated through their full range of motion at 100 psi (6.9 bar or 690 kPa) with no signs of leaking, binding or other problems.
4. Evaluate the flow of nozzles as defined by NFPA 1964 in the following manner:

**Basic Spray Nozzles** shall flow no less than and no more than 10 percent over the rated flow at the rated pressure in the straight stream and wide-angle fog settings.

**Constant and Selectable Gallonage Nozzles** shall flow no less than and no more than 10 percent over the rated flow at the rated pressure at each predetermined flow selection.

*NFPA 1962: Standard for the care, use, inspection, service testing, and replacement of fire hose, couplings, nozzles and fire hose appliances. (2013 ed., Section 5.3). Quincy, MA: National Fire Protection Agency.*

## 12.2.3 RECORDS

A record of testing and repairs must be maintained from the time the nozzle is purchased until it is discarded. Each TFT nozzle is engraved with a unique serial number which, if so desired, can be used to identify nozzle for documentation purposes.

The following information, if applicable, must be included on the test record for each nozzle:

1. Assigned identification number
2. Manufacturer
3. Product or model designation
4. Vendor
5. Warranty
6. Hose connection size
7. Maximum operating pressure
8. Flow rate or range
9. Date received and date put in service
10. Date of each service test and service test results
11. Damage and repairs, including who made the repairs and the cost of repair parts
12. Reason removed from service

*NFPA 1962: Standard for the care, use, inspection, service testing, and replacement of fire hose, couplings, nozzles and fire hose appliances. (2013 ed., Section 5.3). Quincy, MA: National Fire Protection Agency.*

## 12.3 REPAIR

Factory service is available with repair time seldom exceeding one day in our facility. Factory-serviced nozzles are repaired by experienced technicians, wet tested to original specifications, and promptly returned. Repair charges for non-warranty items are minimal. Any returns should include a note as to the nature of the problem and whom to reach in case of questions.

Repair parts and service procedures are available for those wishing to perform their own repairs. Task Force Tips assumes no liability for damage to equipment or injury to personnel that is a result of user service. Contact the factory or visit the web site at [www.tft.com](http://www.tft.com) for parts lists, exploded views, test procedures and troubleshooting guides.

 **Any alterations to the nozzle and its markings could diminish safety and constitutes a misuse of this product.**

## 14.0 OPERATION and INSPECTION CHECKLIST

**Before each use** the nozzle must be inspected to this checklist;

- 1) There is no damage to the appliance that could impair safe operation (e.g. dents, cracks, corrosion, missing, broken or loose parts, damaged markings, or other defects)
- 2) Debris screen is free of debris
- 3) Coupling is tight and leak free
- 4) Valve operates freely through full range and regulates flow
- 5) "OFF" position does fully shut off and flow is stopped
- 6) Nozzle flow is adequate as indicated by pump pressure and nozzle reaction
- 7) Shaper turns freely and adjusts pattern through full range
- 8) Shaper turns into full flush and out of flush with normal flow and pressure restored

**Before being placed back in service**, nozzles must be inspected to this checklist;

- 1) All controls and adjustments are operational
- 2) Shut off valve (if so equipped) closes off the flow completely
- 3) There is no damage to the appliance that could impair safe operation (e.g. dents, cracks, corrosion, missing, broken or loose parts, damaged markings, or other defects)
- 5) The thread gasket is in good condition
- 6) The waterway is clear of obstructions
- 7) Nozzle is clean and markings are legible
- 8) Coupling is retightened properly
- 9) Shaper is set to desired pattern
- 10) Shutoff handle is stored in the OFF position

*NFPA 1962: Standard for the care, use, inspection, service testing, and replacement of fire hose, couplings, nozzles and fire hose appliances. (2013 ed., Section 5.3). Quincy, MA: National Fire Protection Agency.*



**Any nozzle failing any part of the checklist is unsafe for use and must have the problem corrected before use or being placed back into service. Operating a nozzle that has failed the checklist is a misuse of this equipment.**